

Technical Data Sheet



Catalog No. P27LF21-7.5

Characteristics	
Phase	1
KVA	7.5
Primary	277V
Secondary	120/240v
Conductor	Aluminum
Temp. Rise	115° C
Frequency	60 HZ
Taps	-2@5%
ESS	No
Insulation	180° C
Weathershield	N/A
Wall Bracket	Built-In
Weight(lbs)	150
Sound(dB)	40

Notes

All units are UL listed and are designed in accordance with applicable NEMA, ANSI and IEEE standards.

Transformers are dry-type AA, non-ventilated NEMA 3R enclosure.

Transformers are wall mounted. Wall mounting bracket is built into the enclosure.

Paint color is ANSI 61.

AMP Ratings

Line In (Primary) @ 277V	27.1A
Load (Secondary) @ 120V	62.5A
Load (Secondary) @ 240v	31.3A

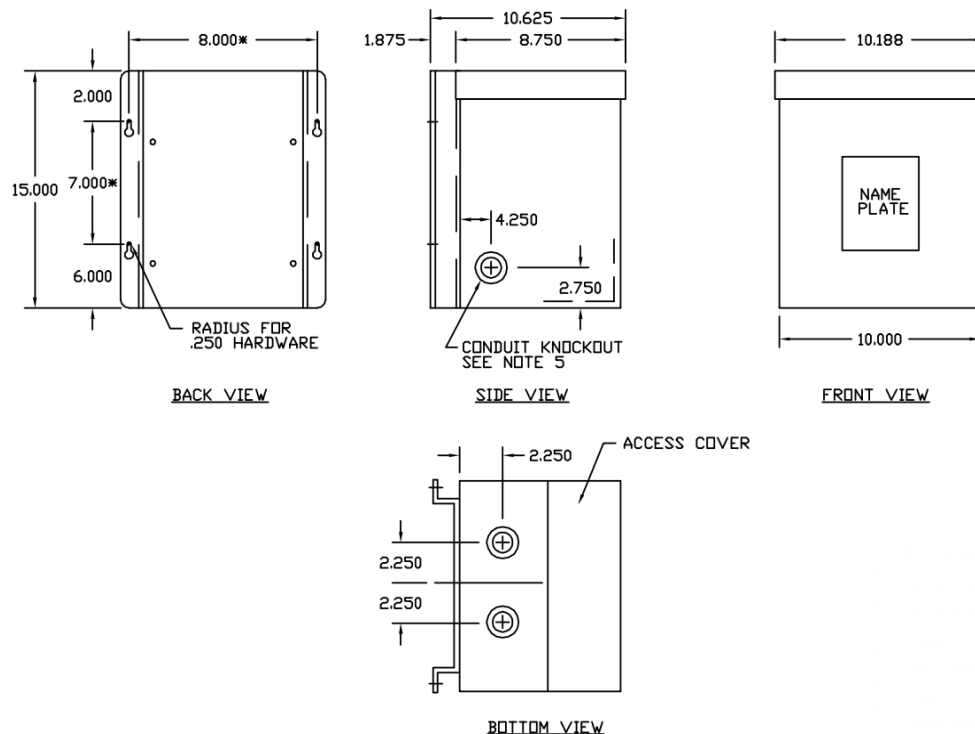
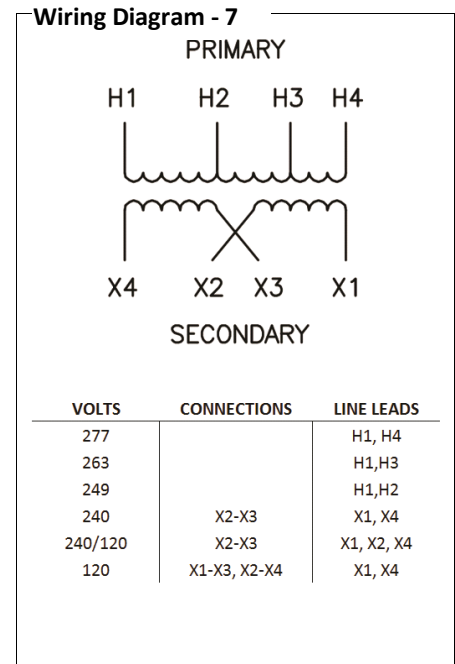

Outline No: 05A1465